

# Handheld Tumor Scanner for Breast Cancer Detection

Zhongyao Zhao, Jun Zhang, Juan Du, Shoko Nioka, Britton Chance  
[zhaozh@mail.med.upenn.edu](mailto:zhaozh@mail.med.upenn.edu) , [junzhang@mail.med.upenn.edu](mailto:junzhang@mail.med.upenn.edu)



Department of Biochemistry and Biophysics  
University of Pennsylvania  
Philadelphia, PA 19104

# Abstract

The amplitude cancellation of in-phase and out of phase of dual source single detector showed remarkable sensitivity to localize small object such as breast tumor with positional accuracy of millimeters. The system design of low frequency, battery operated, mini handheld scanner based the principle of amplitude cancellation is introduced, and performance is evaluated on the phantom simulated the optical properties of tissue and tumor. Some clinical test results is showed.

# Introduction

The principle of amplitude cancellation is showed in Fig. 1. In Fig (1a), there is a amplitude null in the location of detector if S1 ( $0^\circ$ ) and S2 ( $180^\circ$ ) has same power; in Fig(1b), there also is an amplitude null in the location of source if D1 and D2 has same gain.

This null plane will shift if there is a small object such as tumor exists, the blood volume and oxygen consumption of tumor will higher than normal tissue results in an inhomogeneous area. Therefore, the output signal of detector is the function of the of tumor's location if the amplitude cancellation system scans around the tumor.

# Principle of Amplitude Cancellation

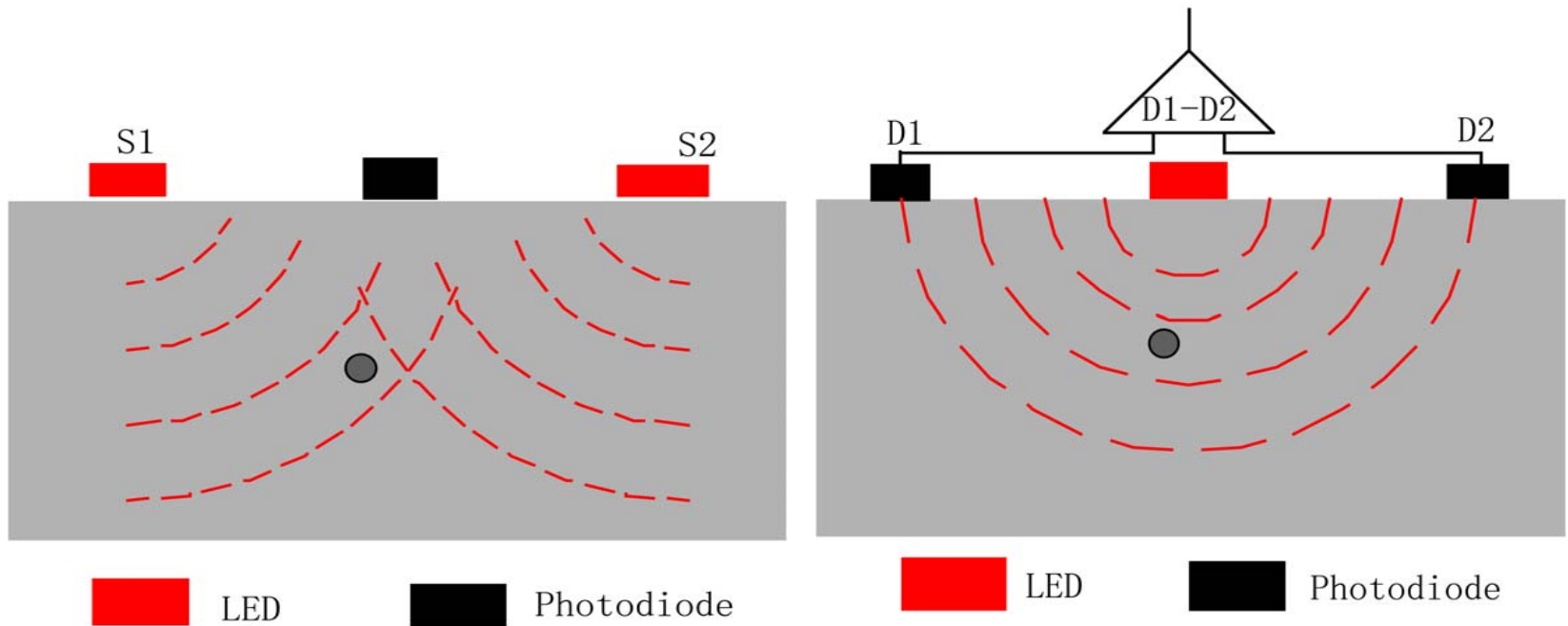

(a) 2 sources 1 detector

(b) 1 source 2 detectors

Fig 1 amplitude cancellation

# Simulation result of two sources/one detector amplitude cancellation by changing the ratio change of light intensity of 2 sources

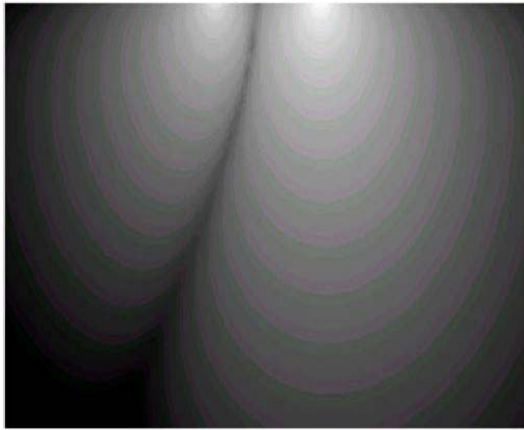

(a)  $S1/S2=1:5$

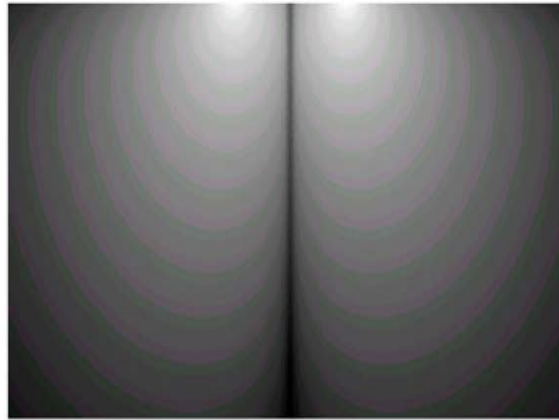

(b)  $S1/S2=1:1$

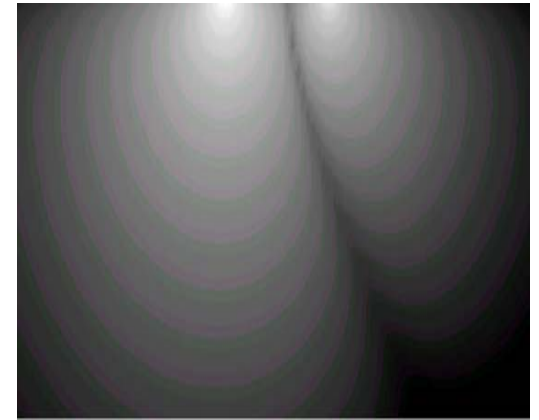

(a)  $S1/S2=5:1$

Fig 2 The parameters for the simulation:  $\mu_a = 0.05 \text{ cm}^{-1}$   $\mu_s' = 10 \text{ cm}^{-1}$ , source detector separation = 2 cm [2]

The amplitude cancellation of systems have remarkable sensitivity to small objects such as breast tumors with positional accuracy of millimeters <sup>[1]</sup> based on our research on several frequency domain systems and CW system. The affordable, battery operated, handheld, single detector dual sources scanner, which has high sensitivity of object detection and localization is tested with phantom. The sensitivity of 50mV/mm is obtained from 10mm diameter blood filled sphere phantom submerged 0.5cm in the scattering, absorbing material simulating the breast. This system is also being used for clinical research now.

# Instrument

The block diagram and circuit schematic of single detector dual sources system is shown in Fig. 4

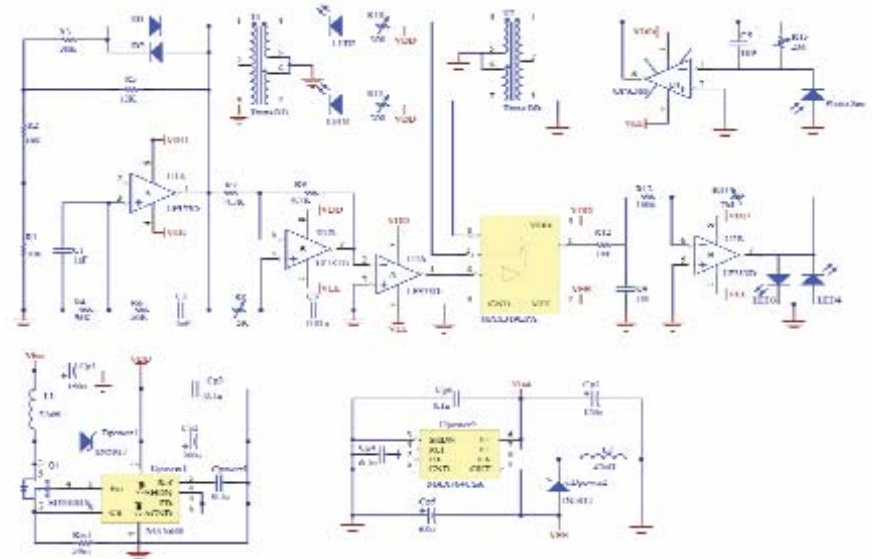
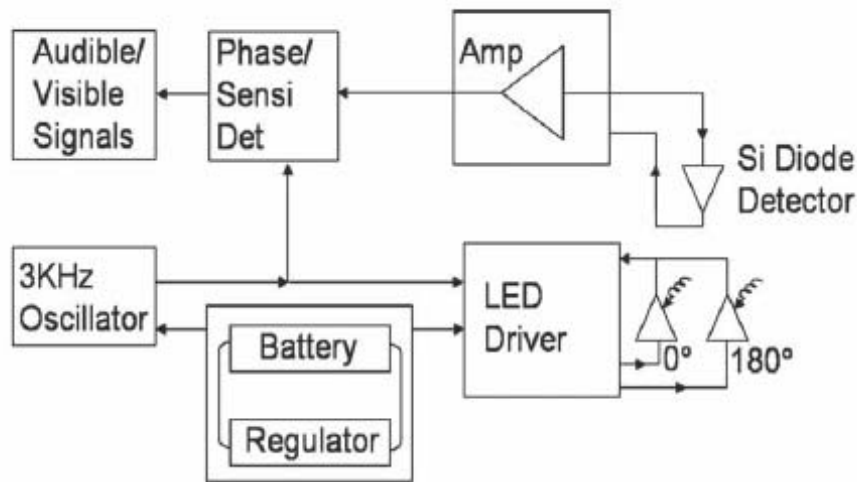

(a) block diagram of 2 source 1 detector system

(b) schematic of 2 source 1 detector system

**Fig 4 circuit design of 2 source 1 detector scanner**

# Photographs of two Hand-Held devices



(a) 2sources 1detector system  
93mm × 65mm × 30mm



(b) 1 sources 2 detectors system  
based on our LED imager

Fig 3 Amplitude cancellation system

# Result and discussion

The detectable area and the depth tumor is related with the source-detector separation, the maxim signal is  $1/2$  source-detector separation approximately, and the field of view (FOV) is roughly 1 and  $1/2$  separation. For 4cm separation, slop of signal in log is linear for 1cm dia sphere is deep 1 to 4cm. The model test showed that this low cost system has rather high sensitivity, the indicator light can help operator localized the object like tumor. the system has being used in clinical experiment.

# 2-Source/1-Detector Scanner

## Modeling Simulation

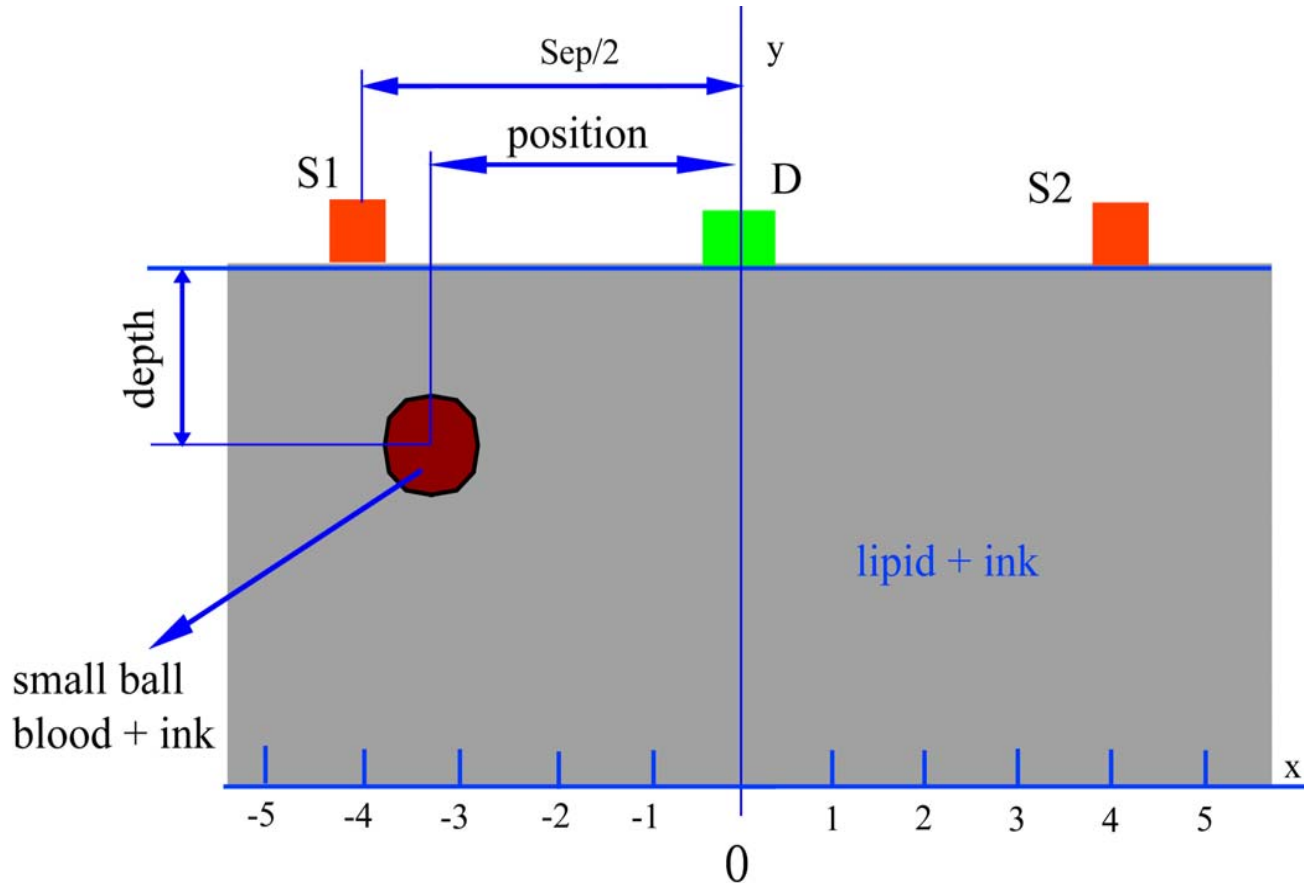

Fig 5 amplitude cancellation system evaluating experiment layout

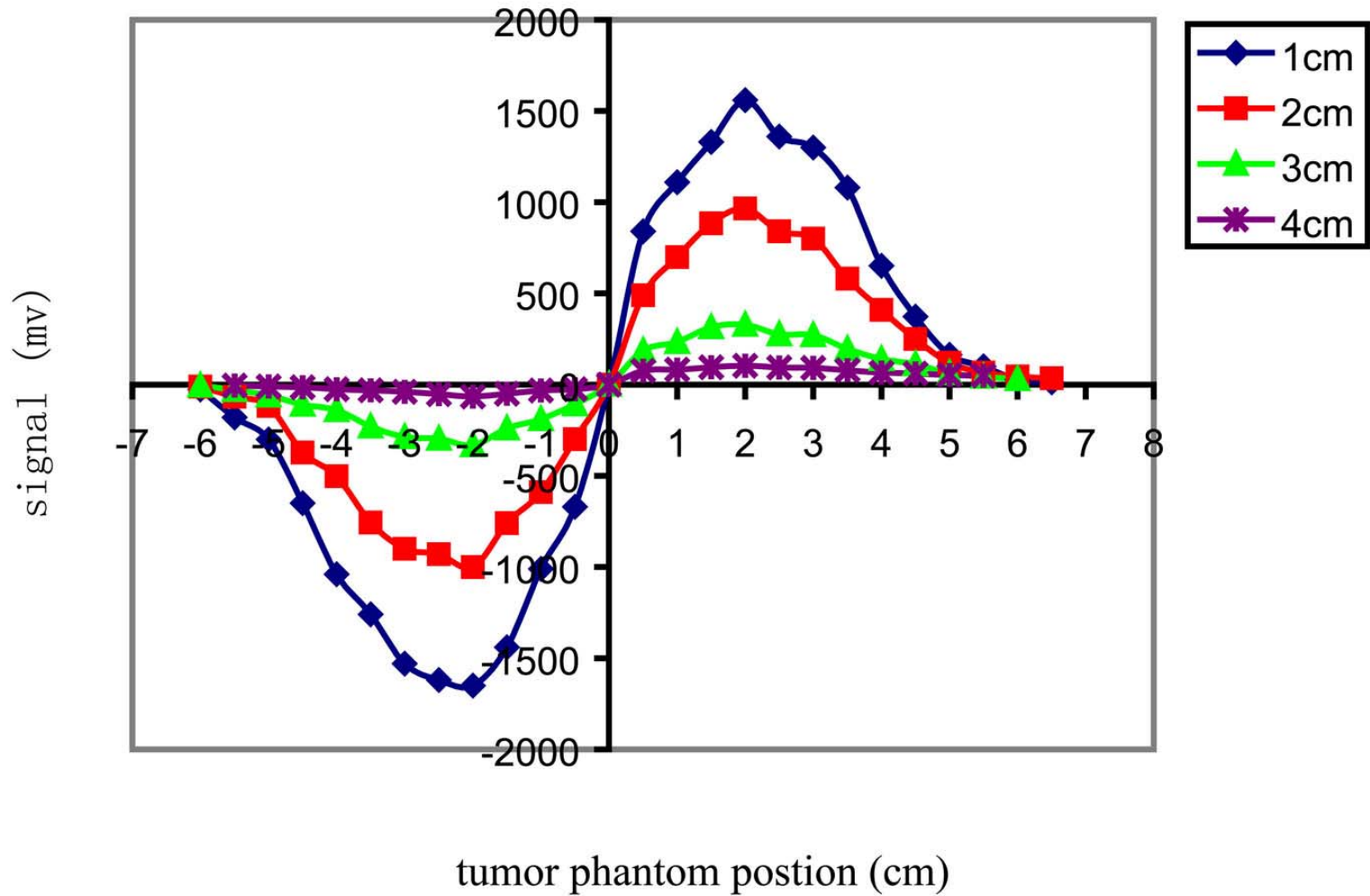
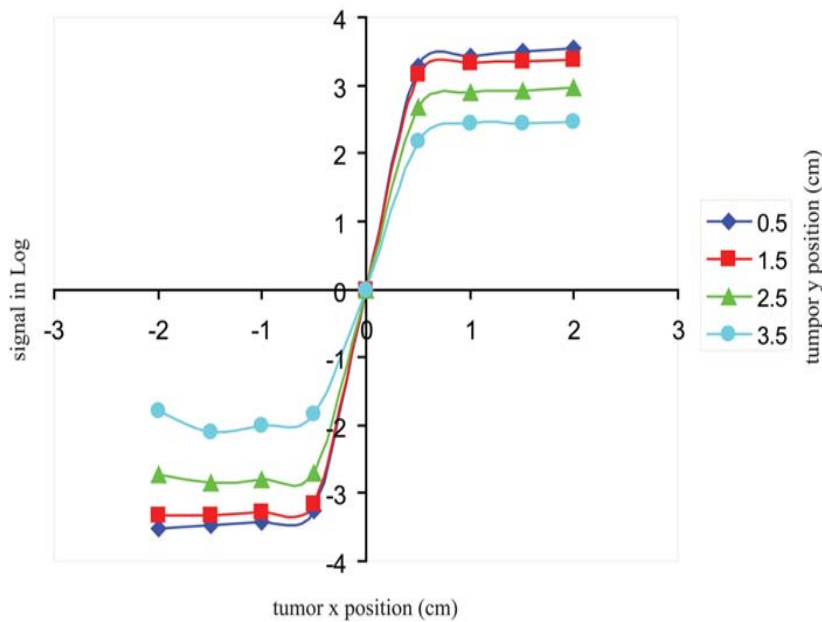
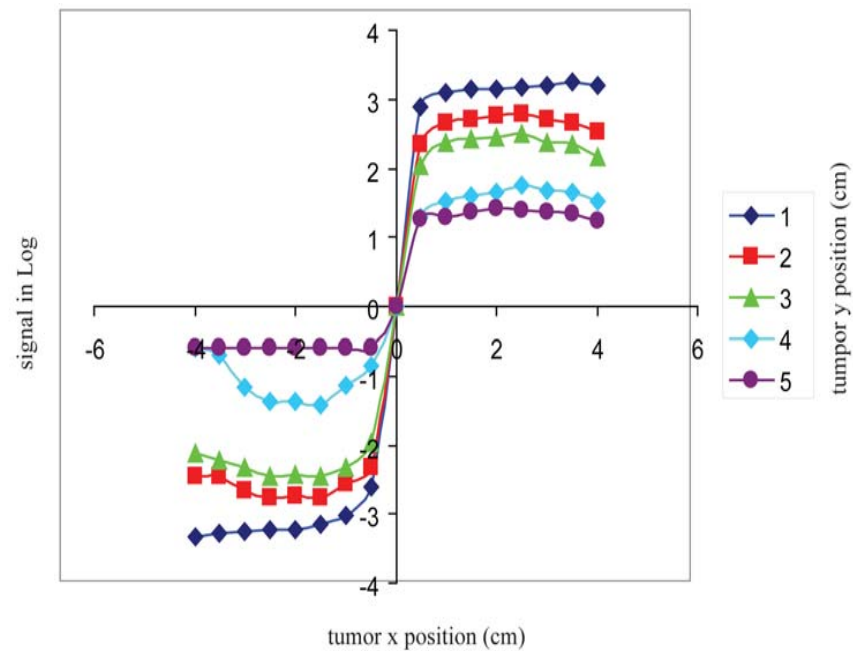

Fig 6 Phantom test raw data of amplitude cancellation system



(a) source detector separation=3cm



(b) source detector separation=4cm

Fig 7 Phantom test response of different source-detector separation

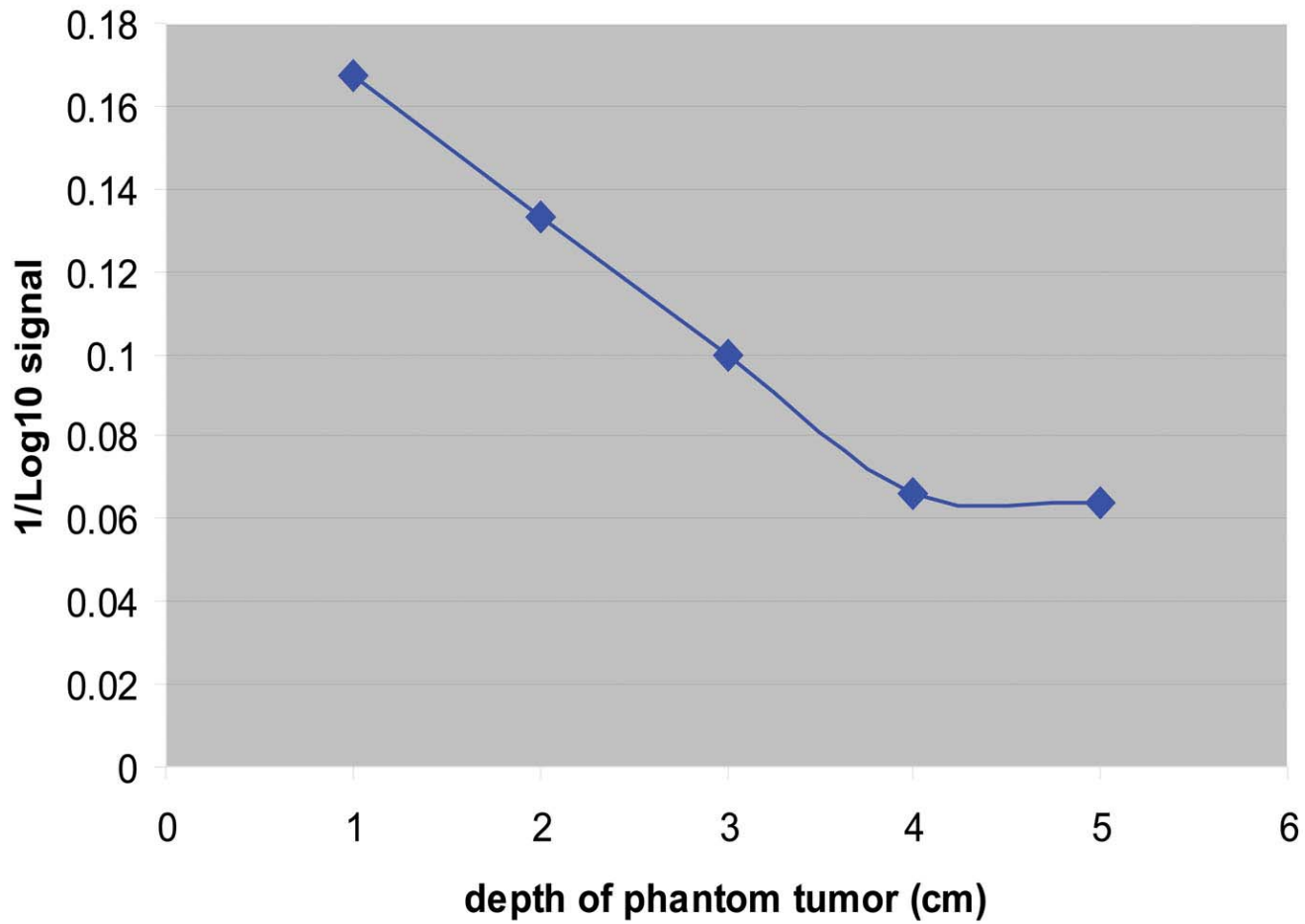

Fig 8 signal as a function of the depth of tumor

# Clinical experiment:

More than 30 subjects has been tested, the result of 14 subjects is showed in table 1. The scanner scans over both L and R breast, each suspicious site being scanned in cross direction. All subjects have also been tested with LED imager, which has being used for many years for breast cancer research.

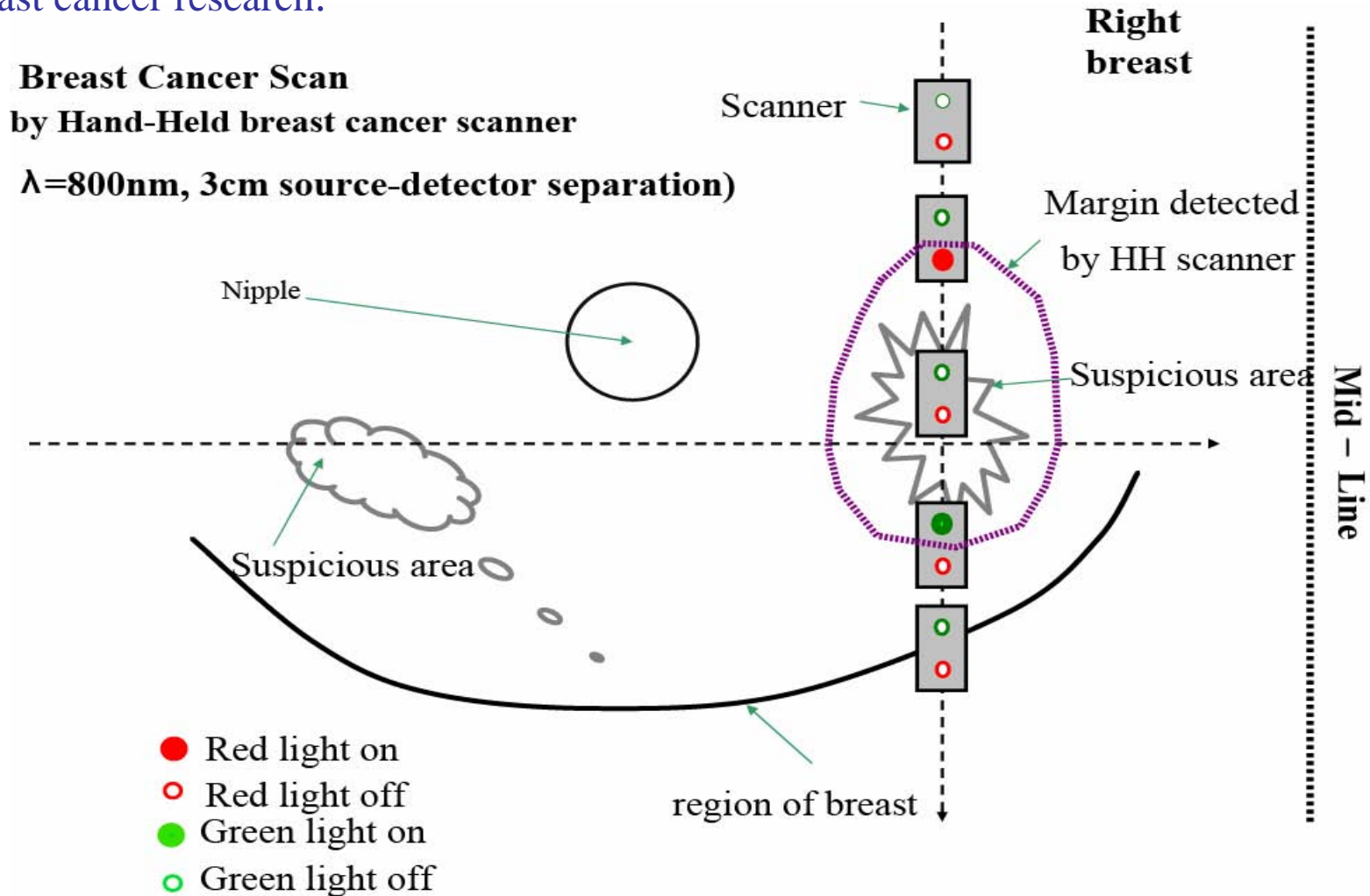

table 1 result of patient data

patient	Histology	R								Diagnosis	Cancer diagnosis
		MU	SU	SL	ML	SU	MU	ML	SL		
1	B(L-MU)	+		+	+	+	<b>X</b>	+		benign detected	FP
2	Ca(R-MU)	<b>☒</b>							+	TP-Ca	TP
3	Ca(L-SU)					<b>☒</b>				TP-Ca	TP
4	C	+	+	+		+	+	+		FP	FP
5	B(L-ML)						+	<b>X</b>	+	benign detected	FP
6	Ca(L-SU)			+		<b>☒</b>				TP-Ca	TP
7	B(L-SU)		+			<b>X</b>	+			detected benign	FP
8	C	+	+			+		+		FP	FP
9	C									TN	TN
10	Ca(L-SU)	+	+	+	+	<b>☒</b>	+	+	+	TP-Ca	TP
11	C									TN	TN
12	Ca(R-SU)		<b>☒</b>							TP-Ca	TP
13	Ca(L-MU)				+	+	<b>☒</b>			TP-Ca	TP
14	C		+	+					+	FP	FP

**Cancer+Benign**

sensitivity: 100%

specificity: 40%

PPV 75%

NPV 100%

**Cancer**

sensitivity: 100%

specificity: 25%

PPV 50.00%

NPV 100%

**NOTES:**

Histology: B- benign; B(L-MU)- benign on left breast, middle up; Ca- cancer; C- control; R- right breast; L- left breast; MU- middle up; SU- side up; SL- side low; ML-middle low;

+: scanner found; **X**: benign scanner found; **☒**: cancer scanner found

TP-Ca: true positive cancer; FP: faults positive; TN: true negative;

Diagnosis: presume cancer and benign diagnosis by scanner as “TP”;

Cancer diagnosis: presume cancer diagnosis by scanner as “TP”

# Case study with LED breast cancer imaging

This is a 60-year-old post menopause woman. Her **Left breast mammogram**: In the upper inner left breast, moderate scattered fibroglandular density is noted, and there remain numerous fine amorphous calcifications adjacent to the surgical biopsy site similar to those which were excised with benign result. Further, there appear to be subtle sutural calcifications in the approximate 10 o'clock position.

**We got NIR signal at D2.**

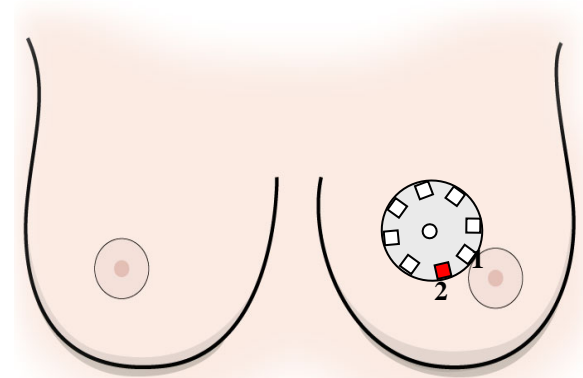
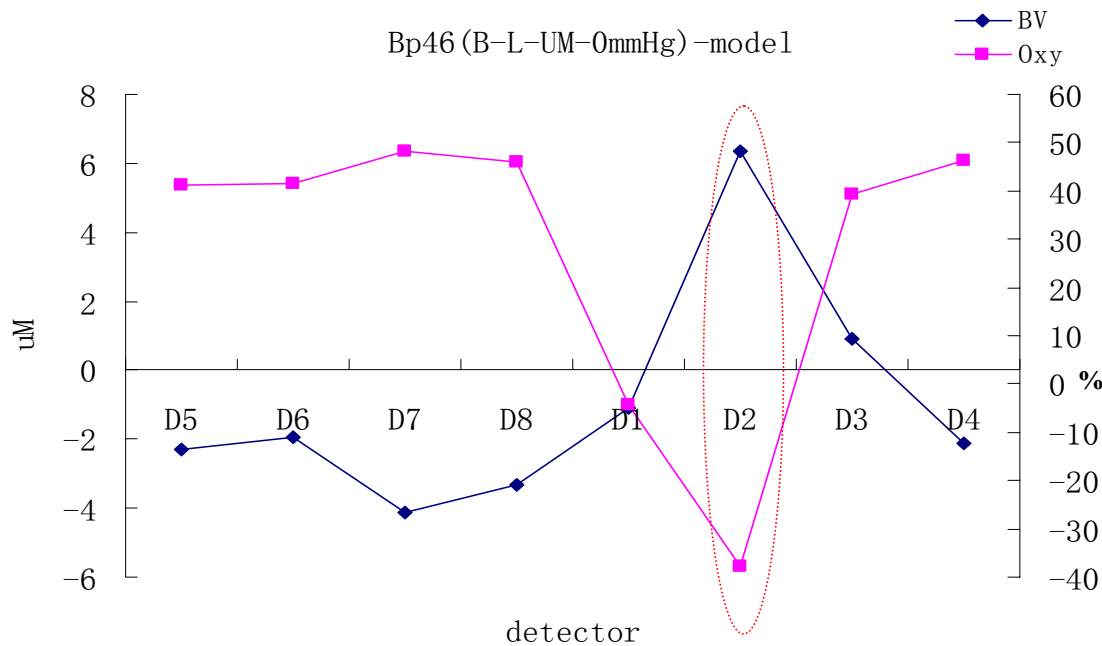

**Put on the Right breast up inner quadrant, there has NIR signal on D8.**

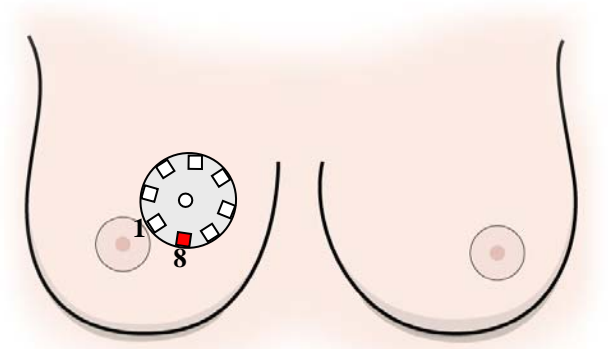
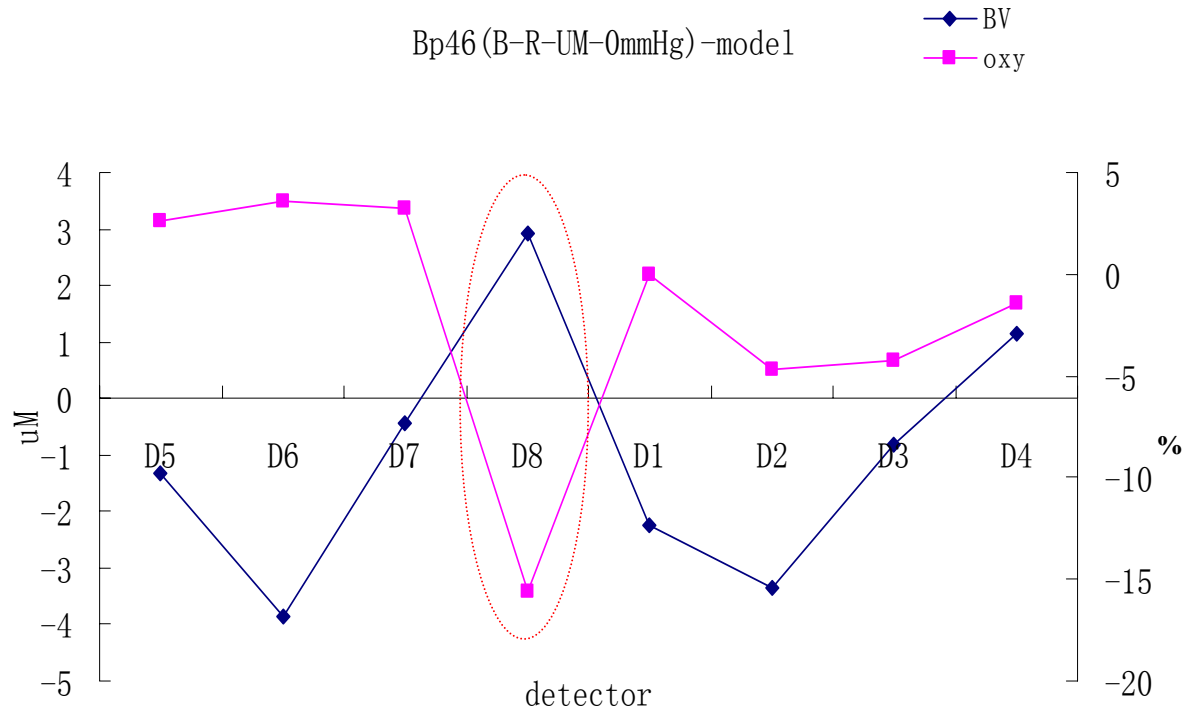

# The case fits to the published chart

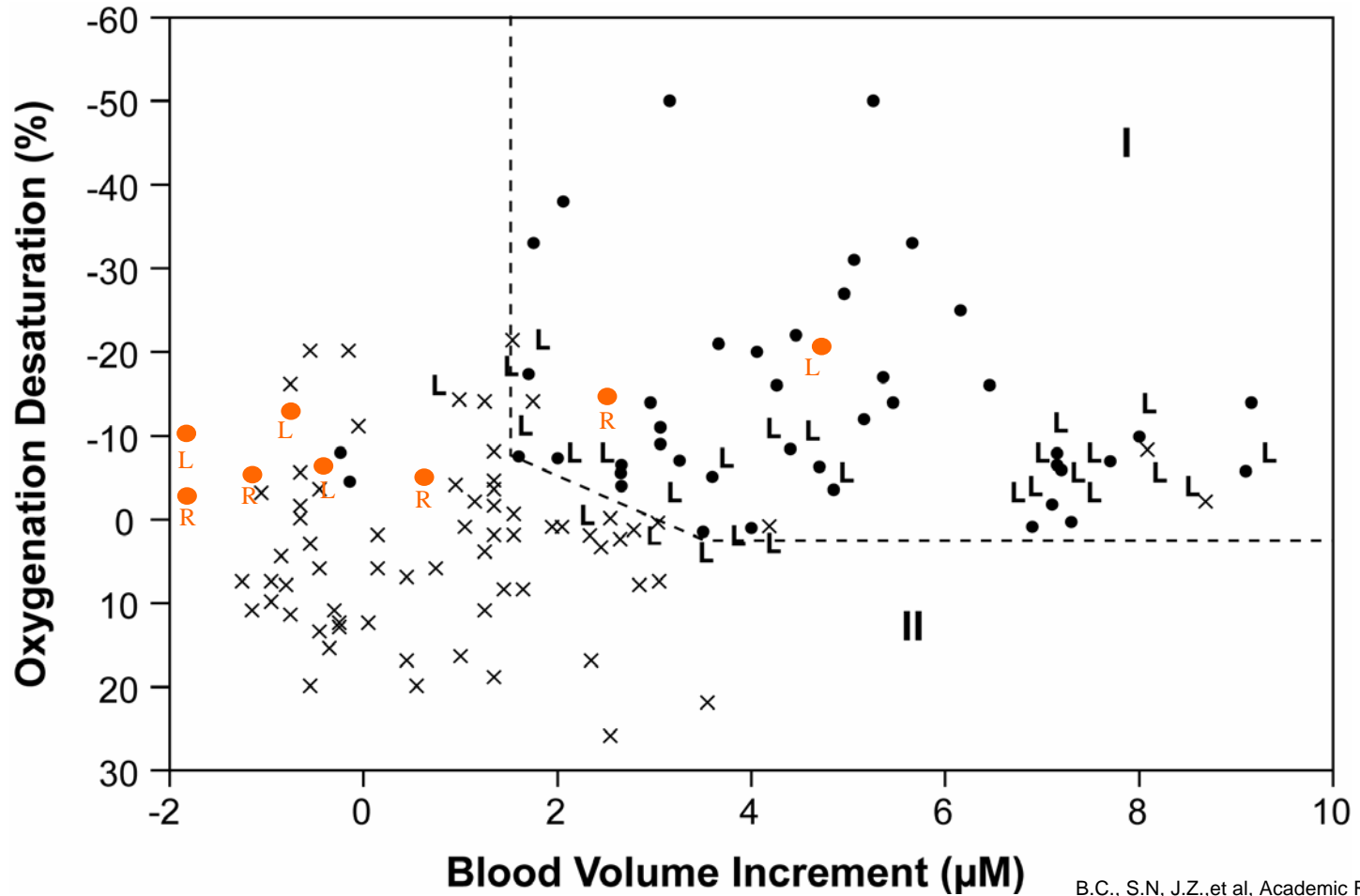

B.C., S.N, J.Z., et al, Academic Radiology 2005

L-left breast; R-right breast; L-leipzig

The two-dimensional nomogram display of currently available NIR breast cancer data. The abscissa is relative increments of blood concentration in units of micromolar concentration change with respect to the average cancer-free value. The ordinate represents incremental change with respect to the average cancer-free value in percent change of hemoglobin saturation. The reference values (zero for saturations and blood volumes) are based on the contralateral cancer-free breast as represented by a congruence. The wavelengths are at 760 and 850 nm, and the incremental concentrations are appropriately processed for the weighted sum and difference quantities for blood concentration and saturation change, respectively, with 70% and 50  $\mu\text{M}$  the reference points (0) for the two metrics. The data cover studies from 1997 to 2003. Verified cancers are indicated with a dot and cancer-free breasts plotted with an X. Data from Leipzig are marked L, data from Philadelphia are not marked. The nomogram is divided into two parts, one containing the verified cancers (I) and the other containing the cancer-free breasts (II).

# Reference

1. B. Chance, Z. Zhao, S. Wen, Y. Chen, A simple AC circuit for breast cancer detection and object detection. *Rev. Sci. Instrum.* 77(1) 2006
2. B. Chance, Shoko Nioka, Jun Zhang, et al. Breast cancer detection based on incremental biochemical and physiological properties of breast cancer: A six-year, two-site study, *Acad Radiol.* 2005 Aug; 12(8): 925-933.
3. B. Chance, B. Onaral, Hand-Held Optical Scanner for Early Detection of Breast Cancer, September 15, 2004.  
[www.biomed.drexel.edu/entrepreneurship/content/nirscan/BreastScanner\\_PressRelease.pdf](http://www.biomed.drexel.edu/entrepreneurship/content/nirscan/BreastScanner_PressRelease.pdf)
4. Y. Chen, Contrast enhancement for diffuse optical spectroscopy and imaging phase cancellation and targeted fluorescence in cancer detection, Dissertation in Bioengineering, University of Pennsylvania (2003).
5. B. Chance, Shoko Nioka and Yu Chen, Shining new Light on Brain Function. pp. 17-20, *OE Proc. SPIE*, July 2003.